

Design by Gemma Bernal

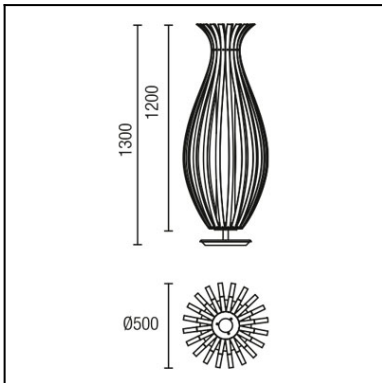

La finition de la photographie peut ne pas coïncider avec celle de la référence. Pour identifier la finition réelle, voir la description de cette dernière.



[Download photometric file .ldt / .ies](#)

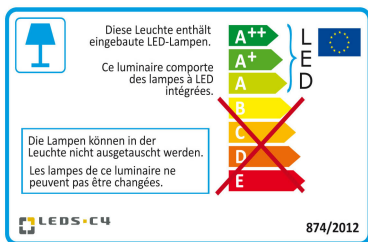

CARACTÉRISTIQUES TECHNIQUES

Type:	Lampadaire
Indice de protection IP:	IP20
Source lumineuse 1:	330 x LED 22W Blanc chaud - 3 000 K 1870 lm ⁽⁰⁾ CRI 80
Tension / Fréquence:	100-240V/50-60Hz
Garantie (Années):	3
Possibilité d'extension de garantie (Années):	5
Unités par caisse:	1
EAN:	8435381433345



MATIÈRES / FINITIONS

Matière structure:	Acier Bois	Matière diffuseur:	PMMA
Finition structure:	rouille peint	Finition diffuseur:	Opale

ÉQUIPEMENT

Équipement électronique multitension compris (100-240V / 50-60Hz)

Cliquez sur l'image pour télécharger l'étiquette-énergie

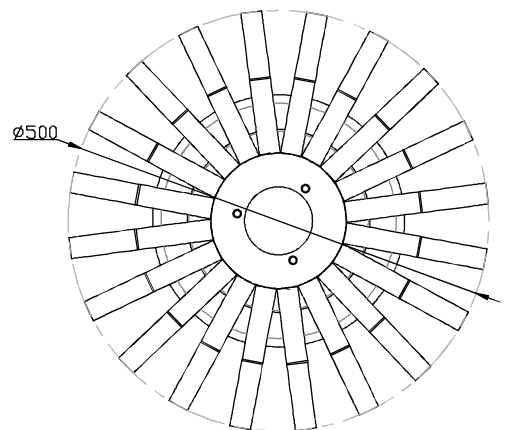
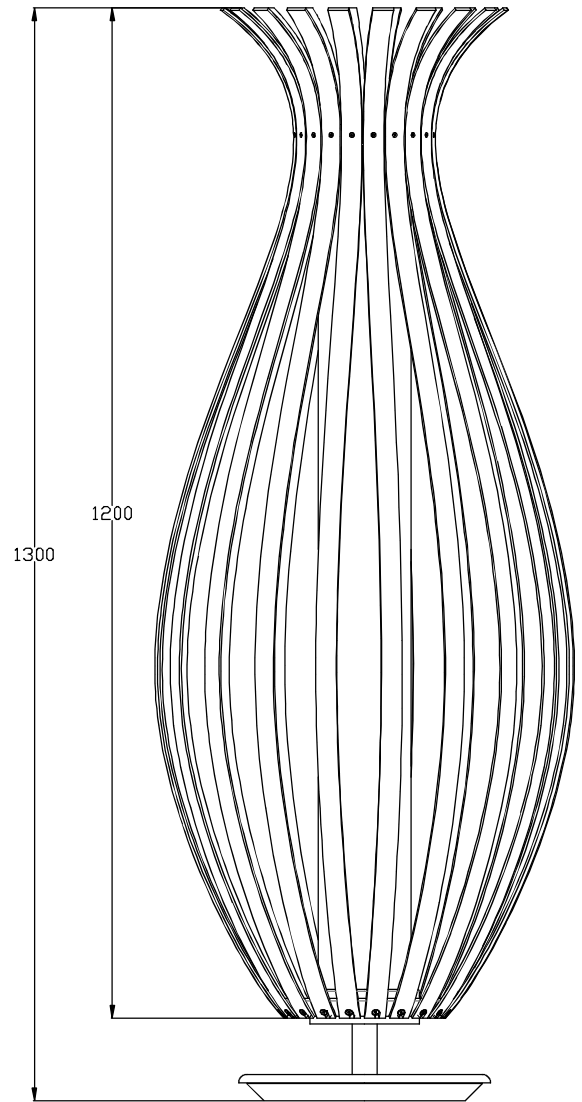
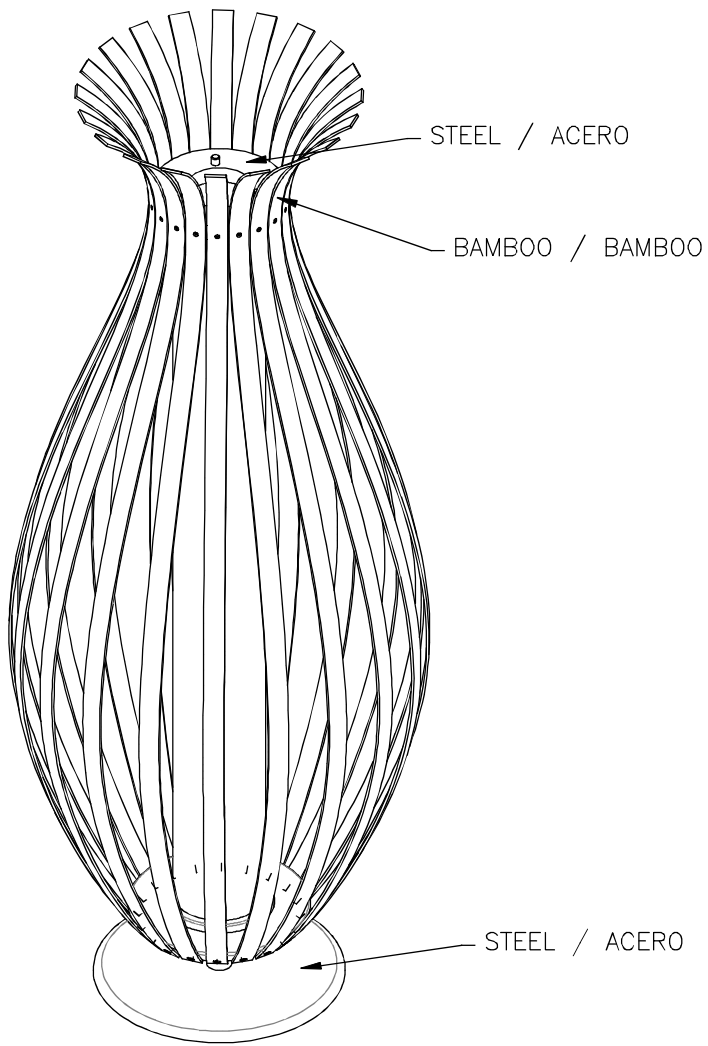

1

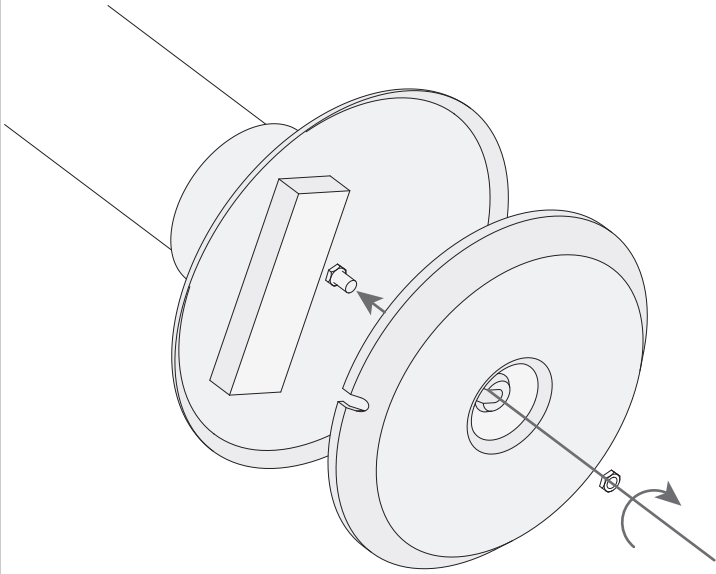

2

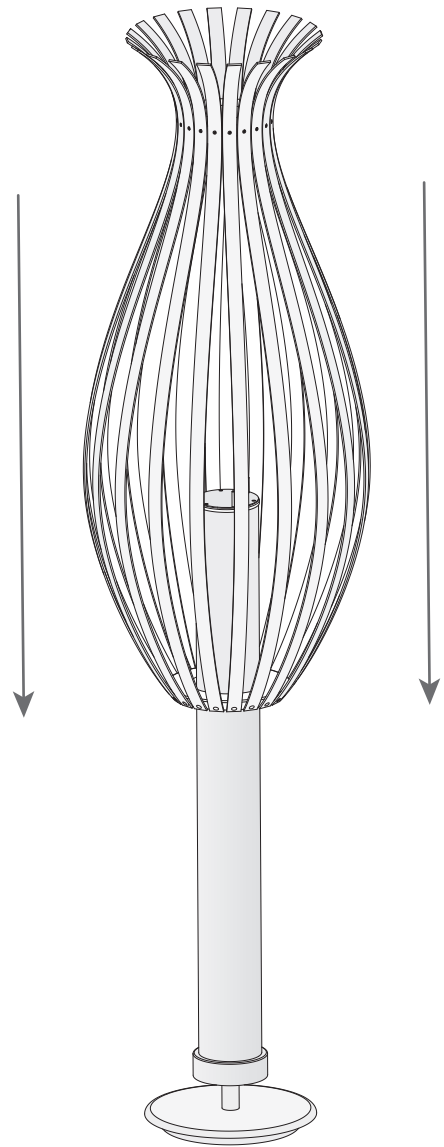

3

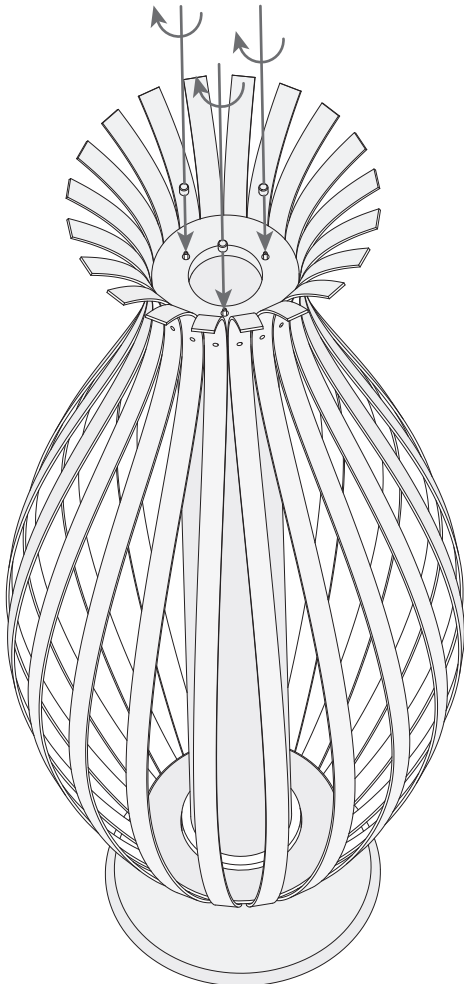

4

