

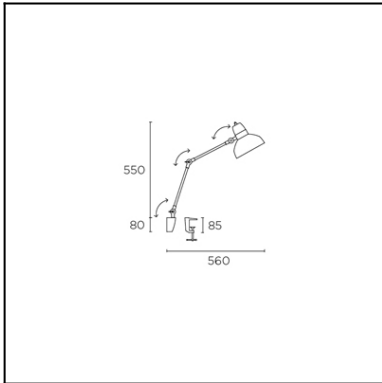

La finition de la photographie peut ne pas coïncider avec celle de la référence. Pour identifier la finition réelle, voir la description de cette dernière.

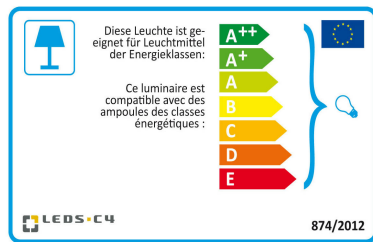

Download photometric file .ldt /.ies



Cliquez sur l'image pour télécharger l'étiquette-énergie

CARACTÉRISTIQUES TECHNIQUES

Type:	Applique
Orientable:	Rotation de $\pm 90^\circ$ sur le plan horizontal. Rotation de $\pm 180^\circ$ sur le plan vertical.
Indice de protection IP:	IP20
Source lumineuse 1:	1 x E27 60W Longueur maximale de la lampe : 130.00 mm Diamètre maximum de la lampe : 70.00 mm
Tension / Fréquence:	220-240V/50-60Hz
Garantie (Années):	2
Unités par caisse:	1
Poids net (kg):	1.26
EAN:	8435381402983



MATIÈRES / FINITIONS

Matière structure:	Acier
Finition structure:	Blanc Chrome

Luminaire		Measur.		Lamp		
Code	05-1531	Code	05-1531	Code	INCANDESCENT	
Name	DESK LAMP	Name	DESK LAMP	Number	1	
Line	Eulumdat	Date	16-11-2013	Position		
Efficiency	64.77%	Coordinate system	CG	Total Flux	710.00 lm	
Maximum value	170.12 cd	Position	C=270.00 G=2.00	Asymmetrical		
Rectangular Luminaire	Length	180 mm	Width	180 mm	Height	1 mm
Rectangular Luminous Area	Length	180 mm	Width	180 mm	Height	0 mm
Horizontal Luminous Area	0.032400 m2	Emitting area on Plane 180°		0.000000 m2		
Emitting area on Plane 0°	0.000000 m2	Emitting area on Plane 270°		0.000000 m2		
Emitting area on Plane 90°	0.000000 m2	Glare area at 76°		0.007838 m2		
Symmetry Type	Asymmetrical	Maximum Gamma Angle		90		
Measurement Distance	0.00	Measurement Flux		710.00 lm		
Operator		Source voltage				
Temperature	25.00 °C	Source current				
Humidity	60.00 %	Photocell				
Notes						

Luminaire Lamps						
Line	Code	Name	Flux [lm]	Pow. [W]	Q.ty	
Eulumdat	INCANDESCENT	INCANDESCENT - 57.40 W	710.00	57.40	1	
C.I.E.	48 83 97 100 65	D DIN 5040		A30		
F UTE	0.65 E	B NBN		BZ 4		

180mm x 180mm

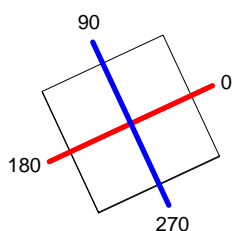

C Halfplanes

180.0 — 0.0

270.0 — 90.0

ULOR 0.00 %

DLOR 64.77 %

RN 0.00 %

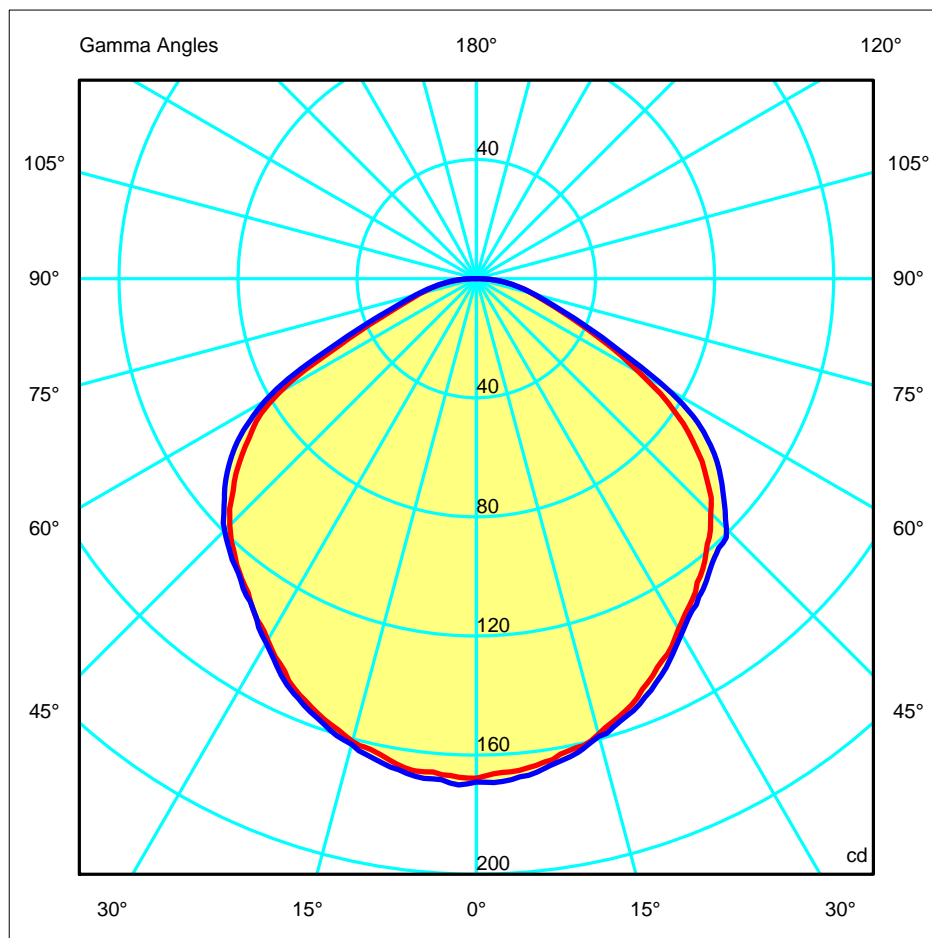

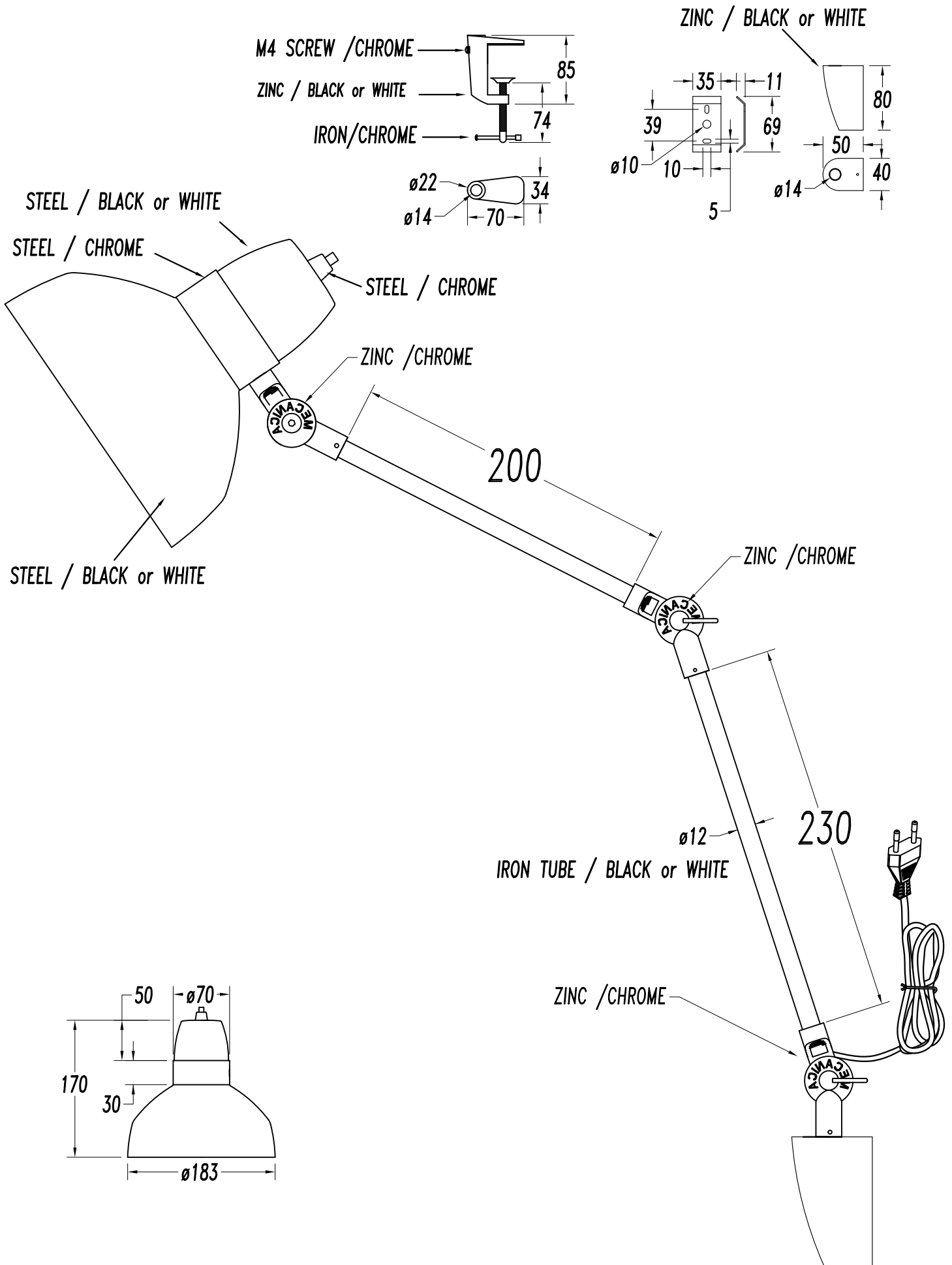

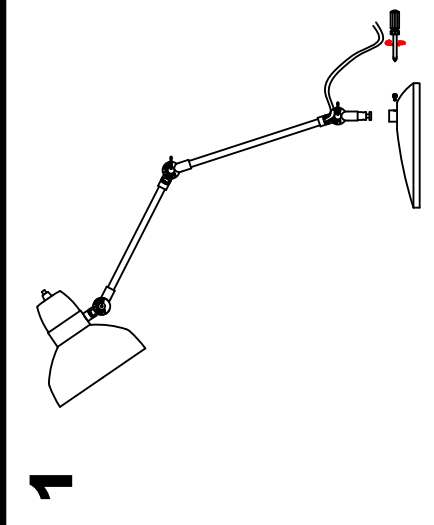
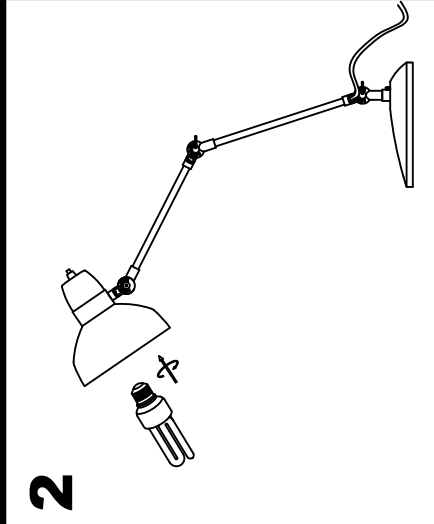
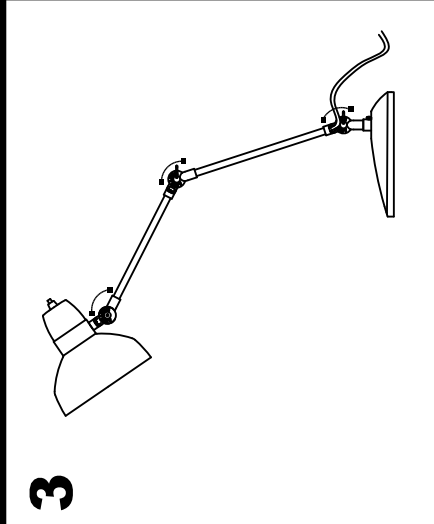
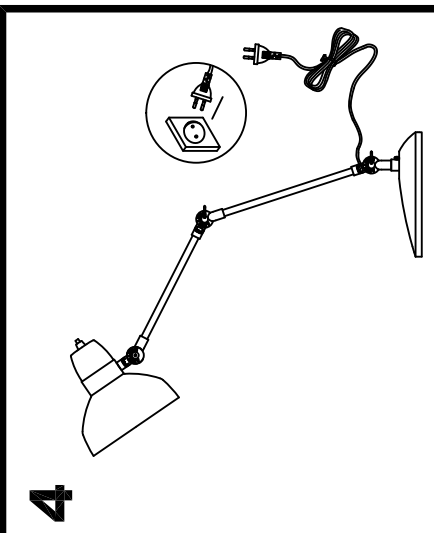
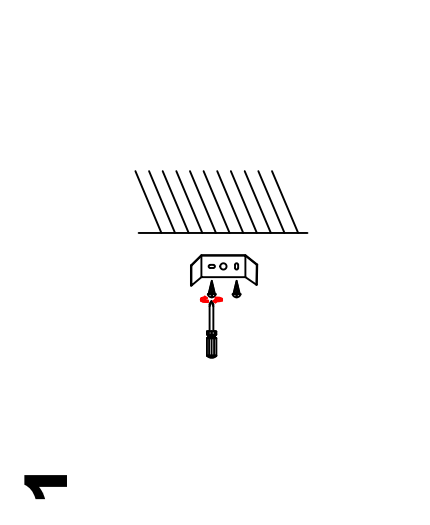
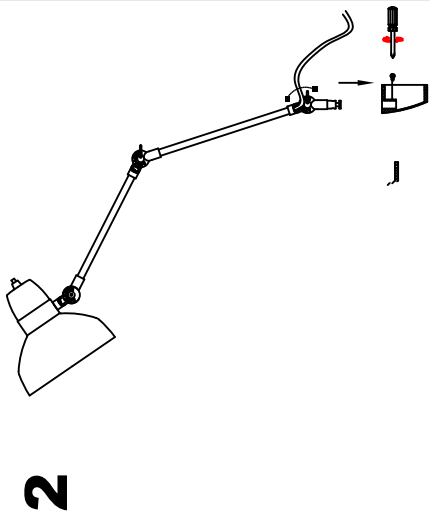
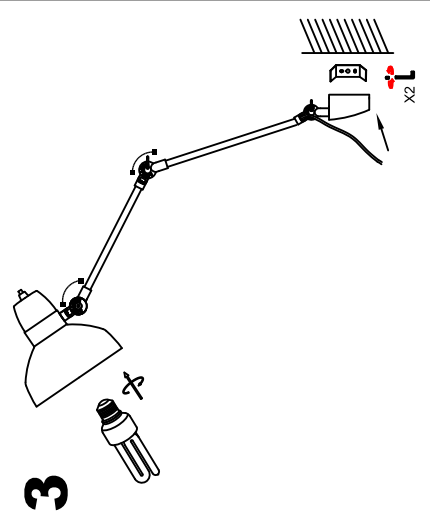
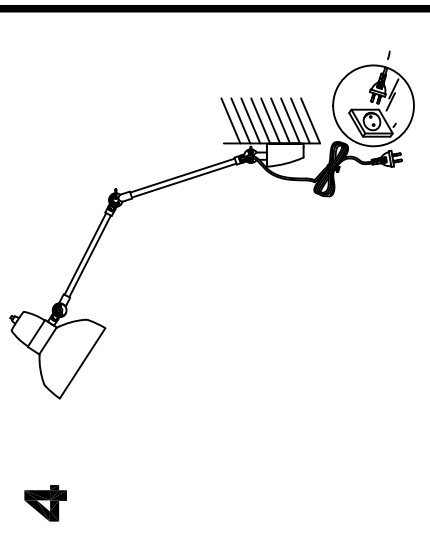
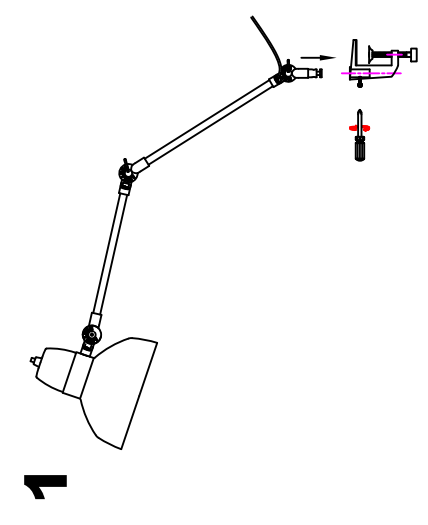
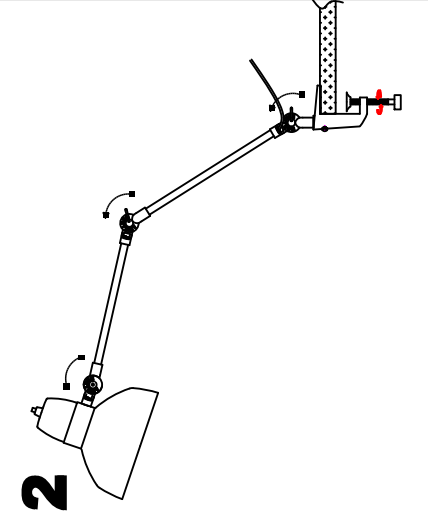
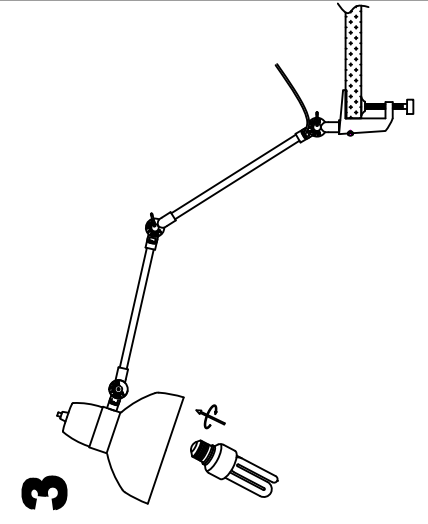
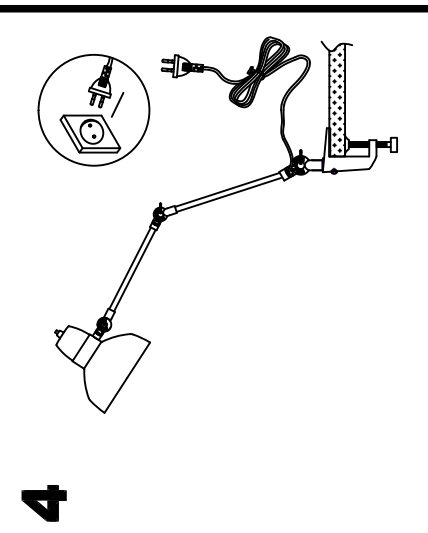
 <p>1</p>	 <p>2</p>	 <p>3</p>	 <p>4</p>
 <p>1</p>	 <p>2</p>	 <p>3</p>	 <p>4</p>
 <p>1</p>	 <p>2</p>	 <p>3</p>	 <p>4</p>